

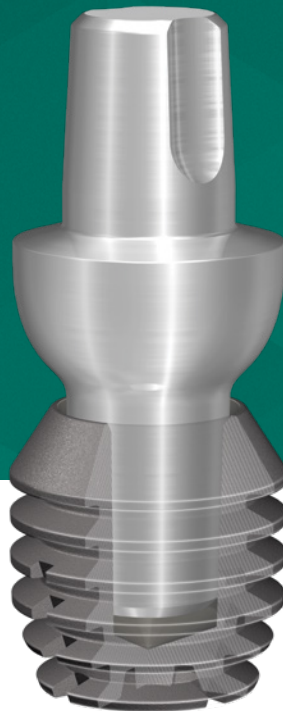

PRODUCT CATALOG



PRODUCT CATALOG

Table of Contents

IMPLANTS	1
SHORT	1
NARROW	1
MAX 2.5	1
TRANSITIONAL IMPLANTS	2
BONE REGENERATION	
SynthoGraft	2
Collagen Products	2
DIGITAL DENTISTRY PRODUCTS	3-4
Scannable Temporary Abutments	3
Digital Scan Posts and Implant Analogs	3
Millable Abutment Blanks	4
TEMPORARY ABUTMENTS	
Scannable	3
Titanium and PEEK	5
Thin Crestal	6
Sinus Lift	6
IMPLANT-LEVEL IMPRESSION PRODUCTS	3-4
Digital Impressions	3
Standard Impressions	4
FINAL STOCK ABUTMENTS	7-10
Universal	7-8
Non-Shouldered	9
Stealth	10
OVERDENTURE AND HYBRID ABUTMENTS	11-14
Brevis	11
Overdenture	12
Fixed-Detachable Universal	13
Fixed-Detachable	14
TRINIA	15
INSTRUMENTATION	16-18
GUIDED SURGERY	19
DEMONSTRATION MODELS	19

IMPLANTS

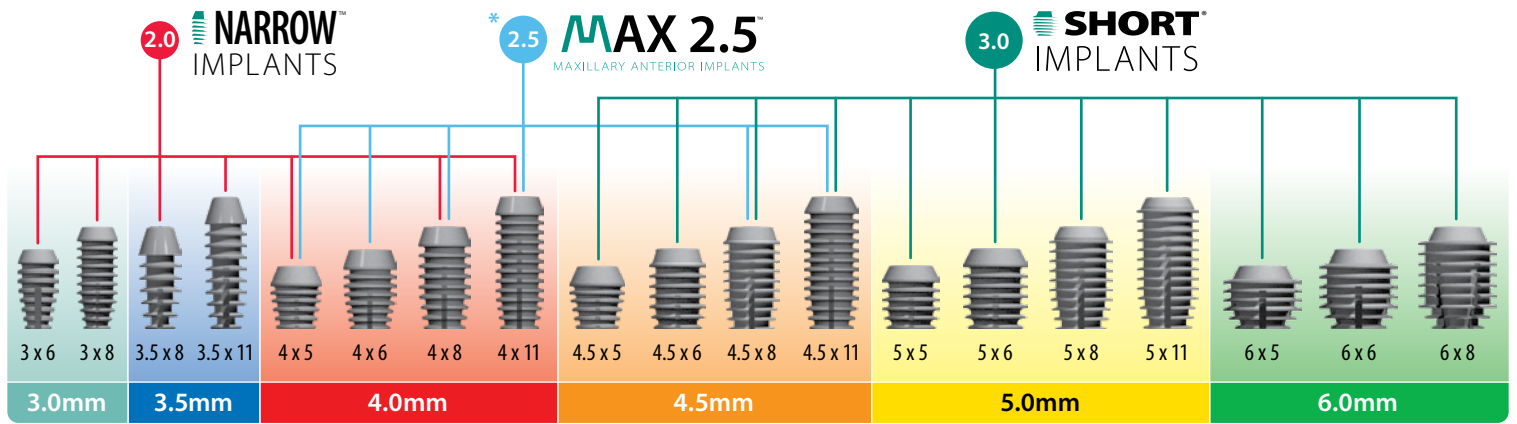

2.0mm Well Integra-CP®

PART NO.	DIAMETER	LENGTH
330-206	3.0mm	6.0mm
330-208	3.0mm	8.0mm
335-008	3.5mm	8.0mm
335-011	3.5mm	11.0mm
340-005	4.0mm	5.0mm
340-008	4.0mm	8.0mm
340-011	4.0mm	11.0mm

2.5mm Well* Integra-CP®

PART NO.	DIAMETER	LENGTH
340-255	4.0mm	5.0mm
340-256	4.0mm	6.0mm
340-258	4.0mm	8.0mm
340-251	4.0mm	11.0mm
345-258	4.5mm	8.0mm
345-251	4.5mm	11.0mm

3.0mm Well Integra-CP®

PART NO.	DIAMETER	LENGTH
345-305	4.5mm	5.0mm
345-306	4.5mm	6.0mm
345-308	4.5mm	8.0mm
345-311	4.5mm	11.0mm
350-305	5.0mm	5.0mm
350-306	5.0mm	6.0mm
350-308	5.0mm	8.0mm
350-311	5.0mm	11.0mm
360-305	6.0mm	5.0mm
360-306	6.0mm	6.0mm
360-108	6.0mm	8.0mm

2.5mm Well* Integra-Ti®

140-258	4.0mm	8.0mm
---------	-------	-------

3.0mm Well Integra-Ti®

145-306	4.5mm	6.0mm
145-308	4.5mm	8.0mm
150-306	5.0mm	6.0mm

***NOTE: 2.5mm well implants have been designed exclusively for maxillary anterior single-unit restorations.** For any other restoration, including maxillary anterior splinted prostheses, overdentures, or fixed-removable applications, it is strongly recommended to avoid 2.5mm well implants.

MANDIBLE

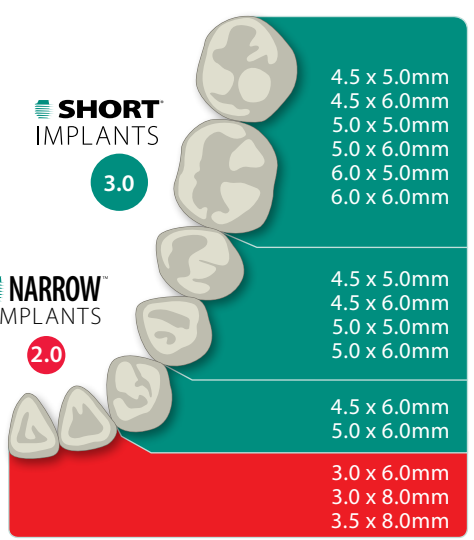

MAXILLA

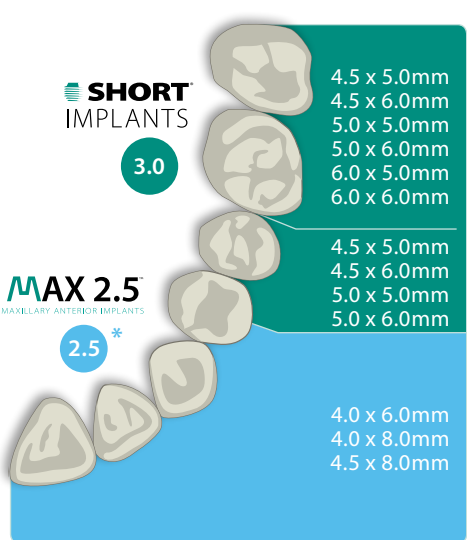

- 2.0mm Well
- 2.5mm Well
- 3.0mm Well

HEALING PLUG INSERTERS



PART NO.	DIAMETER
100-002	2.0mm Post
100-025	2.5mm Post
100-001	3.0mm Post

FDUA TRANSITIONAL IMPLANTS

(FDUA: Fixed-Detachable Universal Abutment)

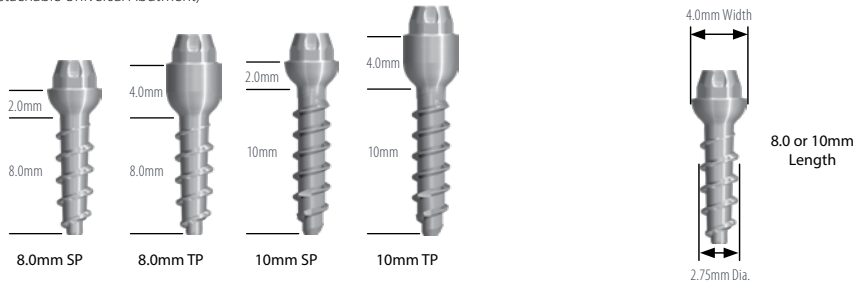

SP: Standard Profile TP: Tall Profile

PART NO.	DIAMETER	LENGTH	HEIGHT	PART NO.	DIAMETER	LENGTH	HEIGHT
425-318	2.75mm	8.0mm	2.0mm	425-310	2.75mm	10mm	2.0mm
425-328	2.75mm	8.0mm	4.0mm	425-320	2.75mm	10mm	4.0mm

FDUA PROSTHETIC COMPONENTS

(FDUA: Fixed-Detachable Universal Abutment)



PART NO.	DESCRIPTION
100-135	Titanium Transfer Coping (2)
100-130	Titanium Standard Abutment Analog (2)
100-140	Titanium Final Coping (2)

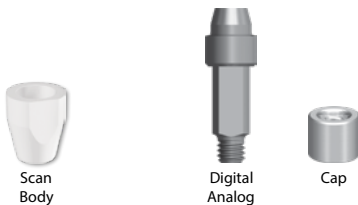

100-640	Scan Body (2)
100-049	Digital Abutment Analog and Cap

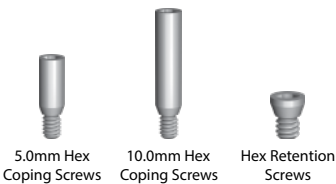

100-016	5.0mm Hex Coping Screws (4)
100-017	10.0mm Hex Coping Screws (4)
100-020	Hex Retention Screws (4)

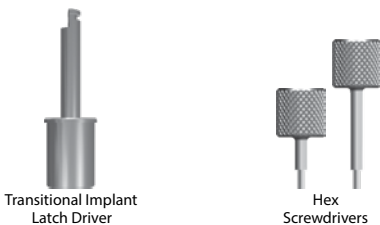

101-904	Transitional Implant Latch Driver
101-024	10mm Hex Screwdriver
101-026	20mm Hex Screwdriver

DEGRANULATION KIT*



PART NO.	DESCRIPTION
GRKIT1	Degranulation Kit

*Latch Round Burs designed to facilitate removal of soft tissue from tooth sockets or walls of bone voids.

BONE GRAFT INSTRUMENTATION

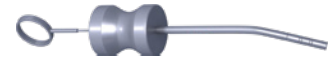

801-510	4.0mm Bone Graft Syringe
801-511	5.0mm Bone Graft Syringe

COLLAGEN PRODUCTS

PART NO.	DESCRIPTION
509-600	15 x 20mm Membrane
509-300	20 x 30mm Membrane
509-800	30 x 40mm Membrane
509-400	Collagen Plug (10)



Membrane



Plug

SYNTHOGRAFT®

PART NO.	PER VIAL	PARTICLE SIZE	VIALS	TOTAL GRAMS	PART NO.	PER VIAL	PARTICLE SIZE	VIALS	TOTAL GRAMS
400-125	0.25g	50-500µm	5	1.25g	400-525	0.25g	500-1000µm	5	1.25g
400-150	0.5g	50-500µm	5	2.5g	400-500	0.5g	500-1000µm	5	2.5g
400-151	1.0g	50-500µm	5	5.0g	400-501	1.0g	500-1000µm	5	5.0g
400-152	2.0g	50-500µm	5	10.0g	400-502	2.0g	500-1000µm	5	10.0g

SynthoGraft®

Pure Phase Beta-Tricalcium Phosphate

SynthoGraft offers:

- ▶ Increased patient acceptance
- ▶ Elimination of the inherent risks associated with biologically-derived bone graft materials
- ▶ Rapid vascularization and subsequent resorption when mixed with the patient's own blood
- ▶ Available in two particle sizes: 50-500µm and 500-1000µm

SCANNABLE TEMPORARY ABUTMENTS

2.0mm Post

PART NO.	SERIES	HEIGHT	SHAFT
143-725	4	2.5mm	Standard
143-795	4	2.5mm	Tall*
143-745	4T	4.5mm	Standard
143-796	4T	4.5mm	Tall*
153-725	5L	2.5mm	Standard
153-745	5	4.5mm	Standard

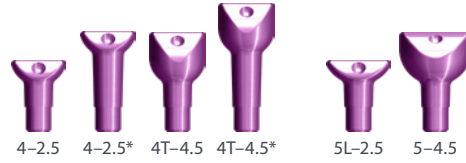

2.5mm Post

PART NO.	SERIES	HEIGHT	SHAFT
243-725	4	2.5mm	Standard
243-795	4	2.5mm	Tall*
243-745	4T	4.5mm	Standard
243-796	4T	4.5mm	Tall*
243-765	4X	6.5mm	Standard
243-797	4X	6.5mm	Tall*
253-725	5L	2.5mm	Standard
253-745	5	4.5mm	Standard
253-795	5	4.5mm	Tall*
253-765	5T	6.5mm	Standard
253-796	5T	6.5mm	Tall*
253-785	5X	8.5mm	Standard

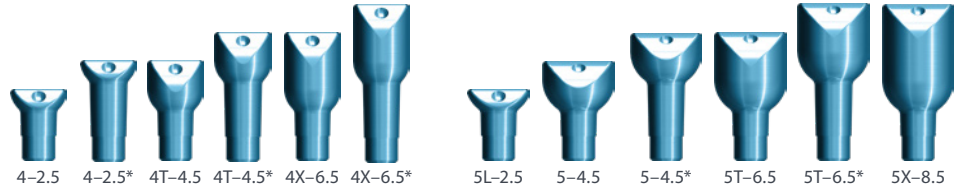

3.0mm Post

PART NO.	SERIES	HEIGHT	SHAFT
353-725	5L	2.5mm	Standard
353-745	5	4.5mm	Standard
353-795	5	4.5mm	Tall*
353-765	5T	6.5mm	Standard
353-796	5T	6.5mm	Tall*
353-785	5X	8.5mm	Standard
363-725	6L	2.5mm	Standard
363-745	6	4.5mm	Standard
363-765	6T	6.5mm	Standard
373-725	7L	2.5mm	Standard
373-745	7	4.5mm	Standard

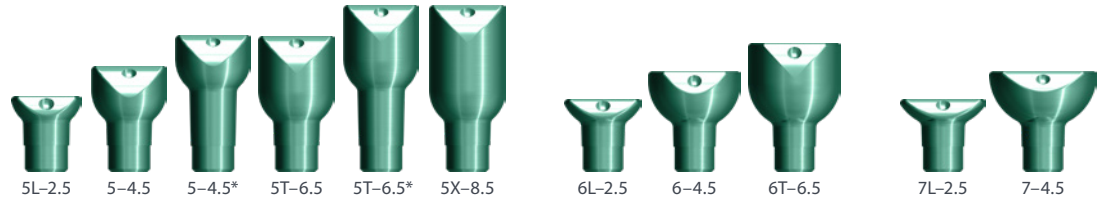

Red 2.0mm Post (Two Dimples)

- 4** Series 4, 2.5mm Height Standard Shaft
- 4** Series 4, 2.5mm Height Tall Shaft
- 4T** Series 4T, 4.5mm Height Standard Shaft

Blue 2.5mm Post (Three Dimples)

- 4X** Series 4X, 6.5mm Height Tall Shaft

Green 3.0mm Post (Four Dimples)

- 5** Series 5, 4.5mm Height Standard Shaft

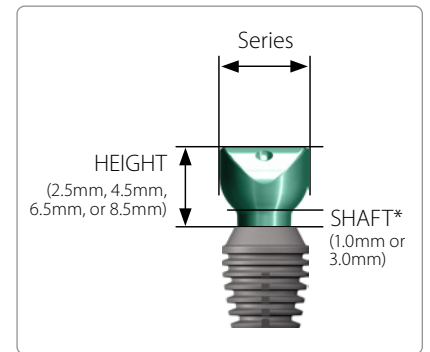

*Tall shafts are 2.0mm taller than standard shafts and are helpful for deeply-positioned implants often avoiding the need for removing bone over the implant with sulcus formers.

The occlusal view of the Scannable Temporary Abutments communicates a variety of information. The abutment color and number of dimples denotes the post diameter. The numeral denotes the series, which is the approximate diameter in mm of the abutment, and the letter denotes the profile's relative height. A circle around the numeral and letter denotes a tall shaft, which is the portion of the abutment post above the top of the implant.

DIGITAL SCAN POSTS (2) (PEEK)

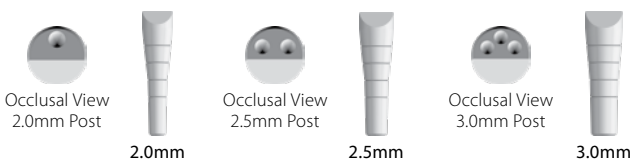

PART NO.	DESCRIPTION
100-610	2.0mm Digital Scan Post
100-620	2.5mm Digital Scan Post
100-630	3.0mm Digital Scan Post

DIGITAL IMPLANT ANALOGS

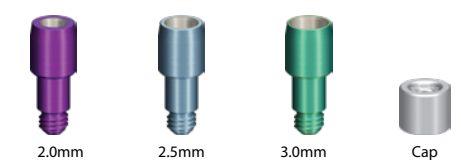

PART NO.	DESCRIPTION
100-199	2.0mm Analog with Cap
100-299	2.5mm Analog with Cap
100-399	3.0mm Analog with Cap

MILLABLE ABUTMENT BLANKS

2.0mm Post

PART NO.	SERIES	DIAMETER	SHAFT
741-700	4	10mm	Standard
741-790	4	10mm	Tall*
744-700	4	14.2mm	Standard
744-790	4	14.2mm	Tall*

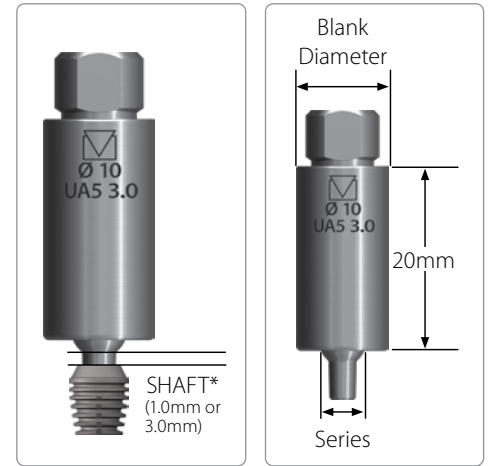
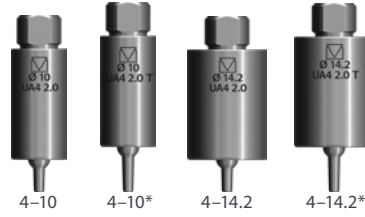

2.5mm Post

541-700	4	10mm	Standard
541-790	4	10mm	Tall*
544-700	4	14.2mm	Standard
551-700	5	10mm	Standard
551-790	5	10mm	Tall*
554-700	5	14.2mm	Standard
554-790	5	14.2mm	Tall*

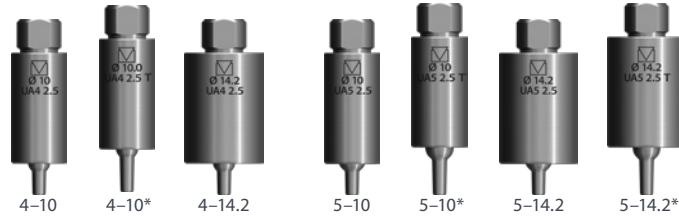

3.0mm Post

651-700	5	10mm	Standard
651-790	5	10mm	Tall*
654-700	5	14.2mm	Standard
654-790	5	14.2mm	Tall*
661-700	6	10mm	Standard
664-700	6	14.2mm	Standard

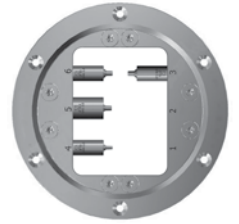
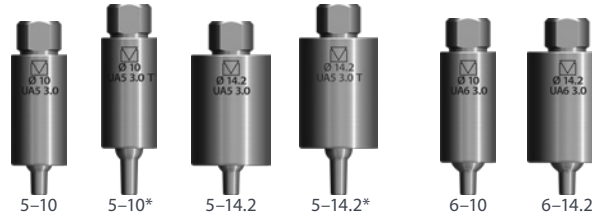

*Tall shafts are 2.0mm taller than standard shafts and are helpful for deeply-positioned implants often avoiding the need for removing bone over the implant with sulcus formers.

IMPLANT-LEVEL IMPRESSION COMPONENTS

2.0mm Post



PART NO.	DESCRIPTION
100-423	Impression Post and Sleeve*
100-424	Implant Level Impression Kit**
100-425	Impression Sleeve (4)
100-188	Implant Analog (2)

2.5mm Post



PART NO.	DESCRIPTION
100-413	Impression Post and Sleeve*
100-414	Implant Level Impression Kit**
100-415	Impression Sleeve (4)
100-288	Implant Analog (2)

3.0mm Post



PART NO.	DESCRIPTION
100-433	Impression Post and Sleeve*
100-434	Implant Level Impression Kit**
100-435	Impression Sleeve (4)
100-388	Implant Analog (2)

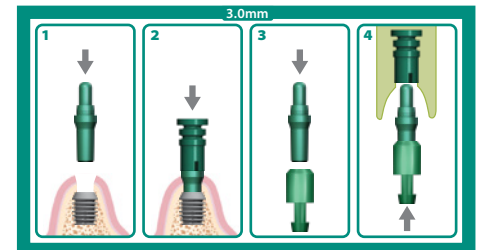
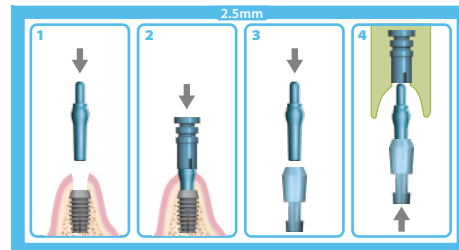
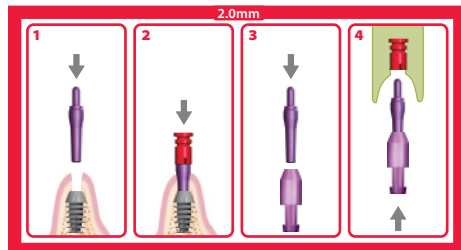

* Contains two titanium impression posts and two plastic impression sleeves. ** Contains one titanium impression post, two plastic impression sleeves and one titanium analog.

TEMPORARY ABUTMENTS (Ti6Al4V)

2.0mm Post

PART NO.	DIAMETER	HEIGHT
140-245	4.0mm	4.5mm
140-265	4.0mm	6.5mm
150-245	5.0mm	4.5mm
150-265	5.0mm	6.5mm

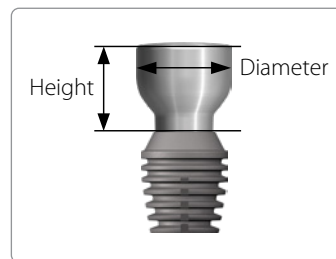
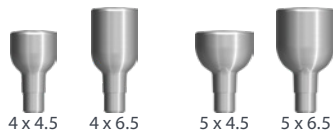

2.5mm Post

240-545	4.0mm	4.5mm
240-565	4.0mm	6.5mm
250-545	5.0mm	4.5mm
250-565	5.0mm	6.5mm

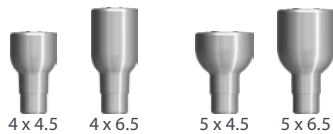

3.0mm Post

340-345	4.0mm	4.5mm
340-365	4.0mm	6.5mm
350-345	5.0mm	4.5mm
350-365	5.0mm	6.5mm
365-345	6.5mm	4.5mm
365-365	6.5mm	6.5mm
375-345	7.5mm	4.5mm
375-365	7.5mm	6.5mm

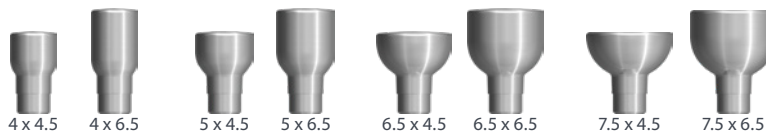

TEMPORARY ABUTMENTS (PEEK)

2.0mm Post

PART NO.	DIAMETER	HEIGHT
140-745	4.0mm	4.5mm
140-765	4.0mm	6.5mm
150-745	5.0mm	4.5mm
150-765	5.0mm	6.5mm

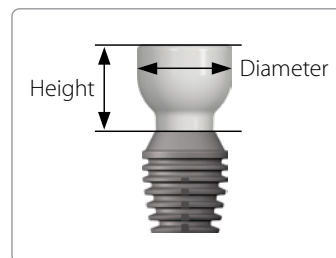
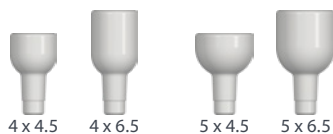

2.5mm Post

240-745	4.0mm	4.5mm
240-765	4.0mm	6.5mm
250-745	5.0mm	4.5mm
250-765	5.0mm	6.5mm



3.0mm Post

340-745	4.0mm	4.5mm
340-765	4.0mm	6.5mm
350-745	5.0mm	4.5mm
350-765	5.0mm	6.5mm
365-745	6.5mm	4.5mm
365-765	6.5mm	6.5mm
375-745	7.5mm	4.5mm
375-765	7.5mm	6.5mm

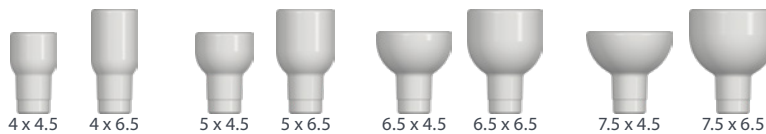

THIN CRESTAL TEMPORARY ABUTMENT

3.0mm Post

PART NO.	LENGTH	WIDTH	SHAFT
370-505	7.0mm	5.0mm	Standard
370-595	7.0mm	5.0mm	Tall*

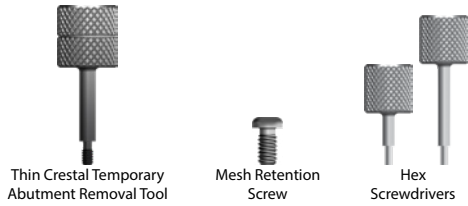

101-505	Thin Crestal Temporary Abutment Removal Tool
100-023	Mesh Retention Screw (2)
101-024	10mm Hex Screwdriver
101-026	20mm Hex Screwdriver

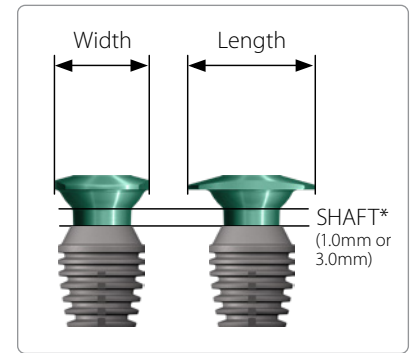
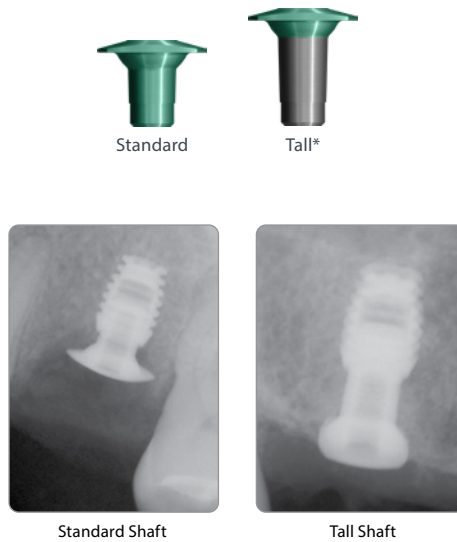

*Tall shafts are 2.0mm taller than standard shafts and are helpful for deeply-positioned implants often avoiding the need for removing bone over the implant with sulcus formers.

SINUS LIFT TEMPORARY ABUTMENTS

2.5mm Post

3.0mm Post

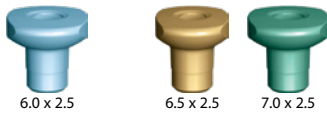

PART NO.	DIAMETER	HEIGHT
260-503	6.0mm	2.5mm
365-503	6.5mm	2.5mm
370-503	7.0mm	2.5mm

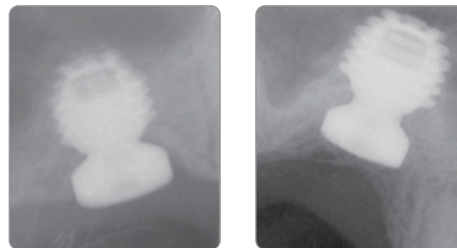

LABORATORY ABUTMENTS*

2.5mm Post

PART NO.	DIAMETER	HEIGHT	ANGLE
550-600	5.0mm	3.0mm	0°
550-605	5.0mm	3.0mm	15°

3.0mm Post

665-600	6.5mm	3.0mm	0°
665-605	6.5mm	3.0mm	15°

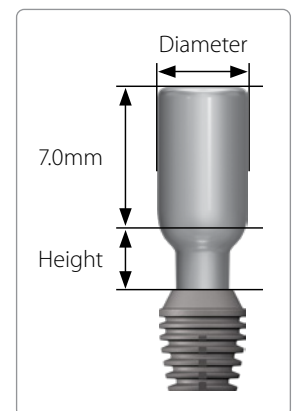
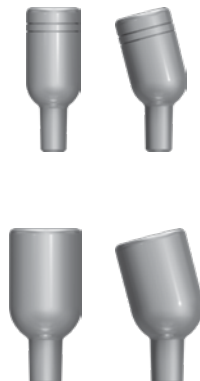

*Designed for the dental laboratory to manually customize abutments for IAC® or PFM restorations.

4-SERIES

5-SERIES

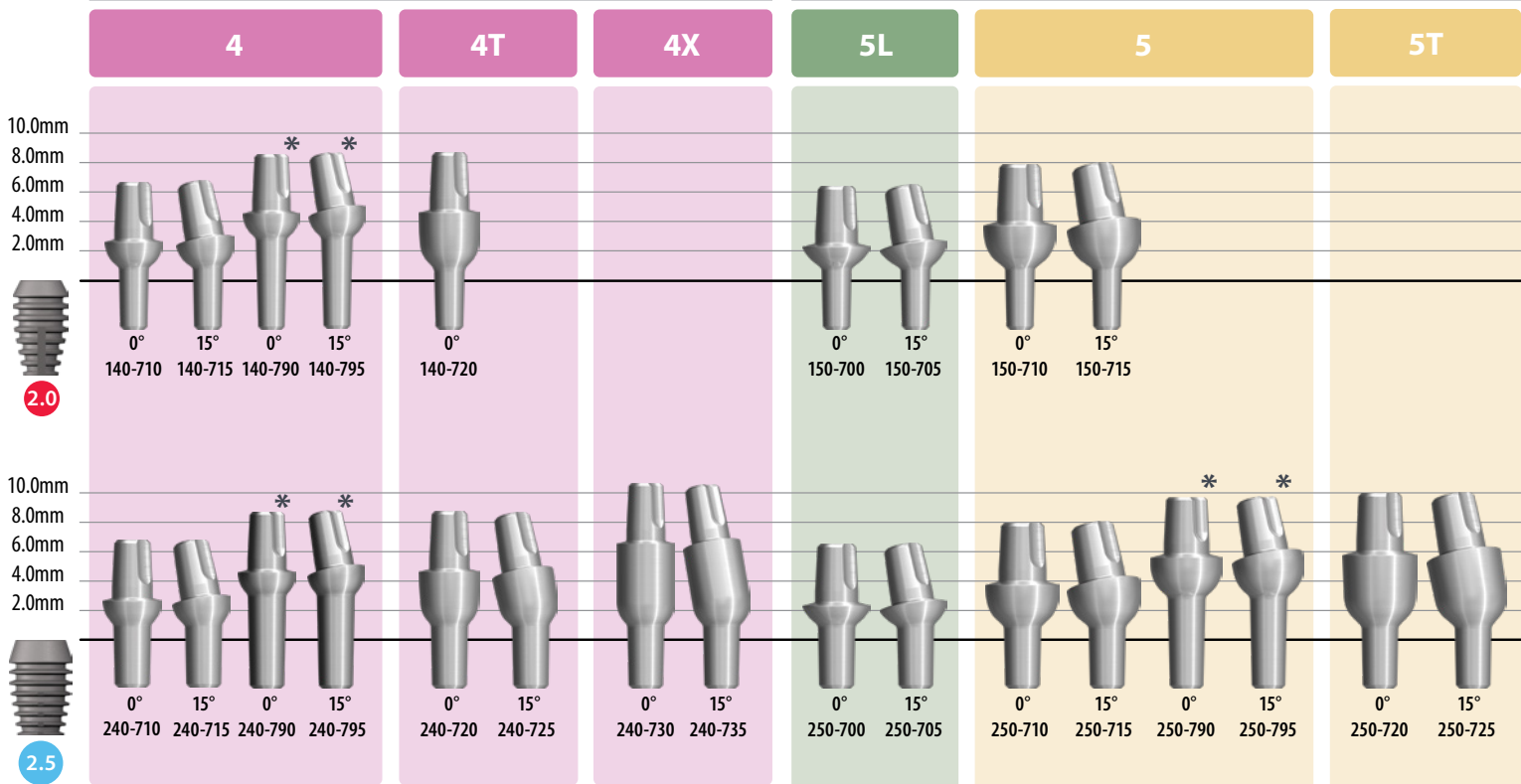

UA COPINGS AND RINGS* (2)



PART NO.	DESCRIPTION
105-700	UA5 LP Retentive Copings
105-705	UA5 LP Passive Copings
105-710	UA5 SP/TP/XP Retentive Copings
105-715	UA5 SP/TP/XP Passive Copings
105-720	UA5 LP Retentive Ring
105-730	UA5 SP/TP/XP Retentive Ring

*Only available for the 5-Series Universal Abutments.

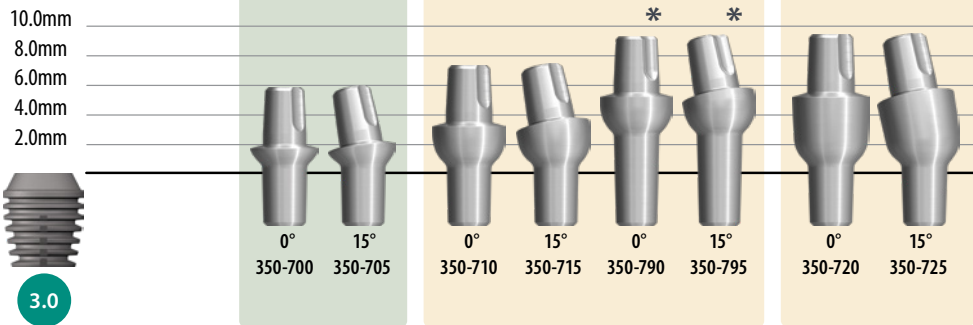

*Tall shafts are 2.0mm taller than standard shafts and are helpful for deeply-positioned implants often avoiding the need for removing bone over the implant with sulcus formers.

UNIVERSAL ABUTMENT PROSTHETIC COMPONENTS

UA Restorative Kits (6-LP Kit Depicted)



PART NO.	SERIES	PROFILE
100-945	4	SP, TP, XP
100-950	5	LP
100-955	5	SP, TP, XP
100-960	6	LP
100-965	6	SP, TP
100-970	7	LP, SP

Temporization Sleeves (3)



PART NO.	SERIES	PROFILE
100-845	4	SP, TP, XP
100-850	5	LP
100-855	5	SP, TP, XP
100-860	6	LP
100-865	6	SP, TP
100-870	7	LP, SP

Waxing Sleeves (3)



PART NO.	SERIES	PROFILE
100-749	4	SP, TP, XP
100-754	5	LP
100-759	5	SP, TP, XP
100-764	6	LP
100-769	6	SP, TP
100-774	7	LP, SP

UNIVERSAL ABUTMENTS (UA)

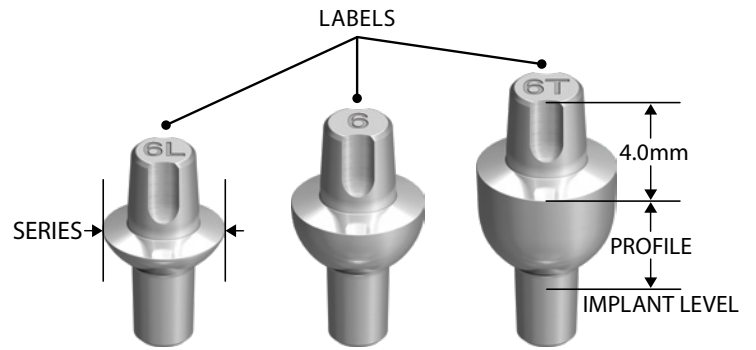
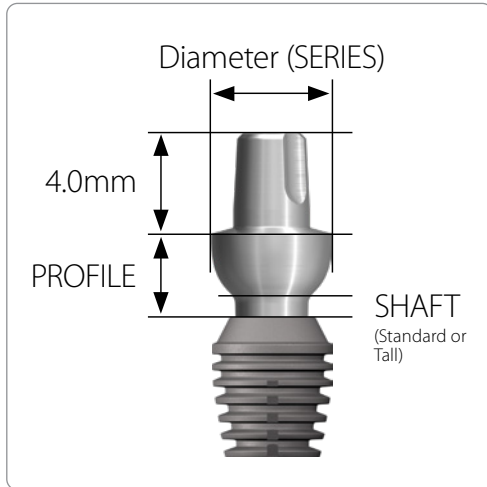
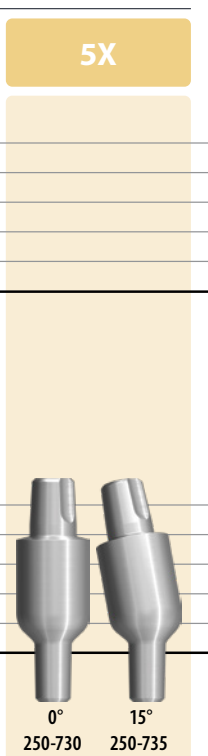

SERIES AND PROFILE LABEL ON ABUTMENT				
SERIES	LOW (L)	STANDARD	TALL (T)	EXTRA-TALL (X)
4		4	4T	4X
5	5L	5	5T	5X
6	6L	6	6T	
7	7L	7		

*Tall shafts are 2.0mm taller than standard shafts and are helpful for deeply-positioned implants often avoiding the need for removing bone over the implant with sulcus formers.

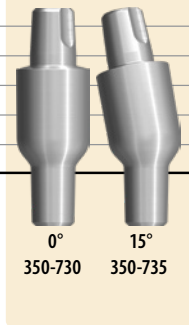

6-SERIES

6L		6		6T	
0°	365-700	0°	365-710	0°	365-720
15°	365-705	15°	365-715	15°	365-725

7-SERIES

7L		7	
0°	375-700	0°	375-710
15°	375-705		

10.0mm
8.0mm
6.0mm
4.0mm
2.0mm

3.0

UNIVERSAL ABUTMENT PROSTHETIC COMPONENTS

Impression Sleeves (3)



Healing Caps (3)

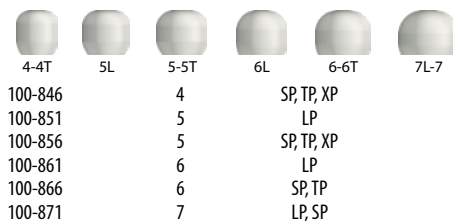

UA Transfer Dies (2)

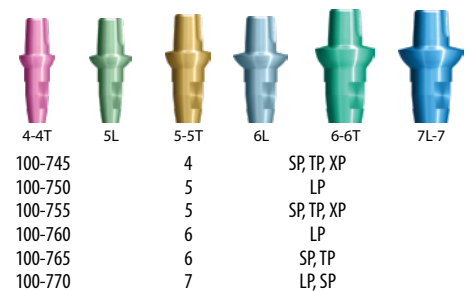

NON-SHOULDERED ABUTMENTS

2.0mm Post

PART NO.	DIAMETER	HEIGHT	ANGLE
140-002	4.0mm	6.5mm	0°
140-015	4.0mm	6.5mm	15°
140-025	4.0mm	6.5mm	25°
140-101	4.0mm	10.0mm	0°
140-115	4.0mm	10.0mm	15°
150-001	5.0mm	6.5mm	0°
150-015	5.0mm	6.5mm	15°
150-025	5.0mm	6.5mm	25°
150-201	5.0mm	12.0mm	0°
150-215	5.0mm	12.0mm	15°

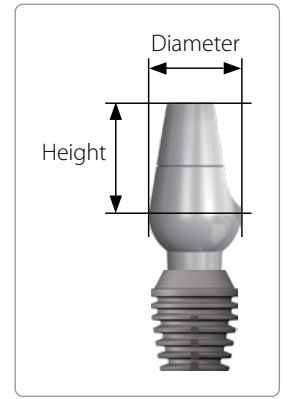
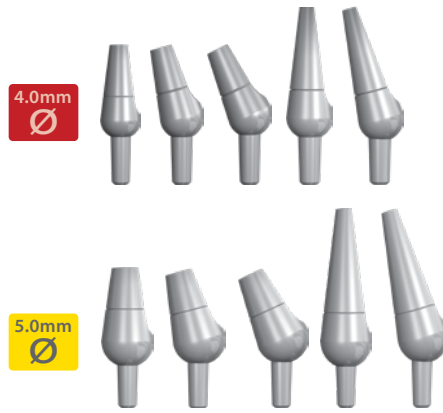

2.5mm Post

PART NO.	DIAMETER	HEIGHT	ANGLE
240-001	4.0mm	6.5mm	0°
240-015	4.0mm	6.5mm	15°
240-025	4.0mm	6.5mm	25°
240-101	4.0mm	10.0mm	0°
240-115	4.0mm	10.0mm	15°
250-001	5.0mm	6.5mm	0°
250-015	5.0mm	6.5mm	15°
250-025	5.0mm	6.5mm	25°
250-111	5.0mm	10.0mm	0°
250-115	5.0mm	10.0mm	15°



3.0mm Post

PART NO.	DIAMETER	HEIGHT	ANGLE
340-001	4.0mm	6.5mm	0°
340-015	4.0mm	6.5mm	15°
340-101	4.0mm	10.0mm	0°
340-115	4.0mm	10.0mm	15°
350-050	5.0mm	5.0mm	0°
350-055	5.0mm	5.0mm	15°
350-001	5.0mm	6.5mm	0°
350-015	5.0mm	6.5mm	15°
350-025	5.0mm	6.5mm	25°
350-101	5.0mm	10.0mm	0°
350-115	5.0mm	10.0mm	15°
350-201	5.0mm	12.0mm	0°
350-215	5.0mm	12.0mm	15°
365-050	6.5mm	5.0mm	0°
365-055	6.5mm	5.0mm	15°
365-001	6.5mm	6.5mm	0°
365-015	6.5mm	6.5mm	15°
375-801	7.5mm	8.0mm	0°
375-815	7.5mm	8.0mm	15°

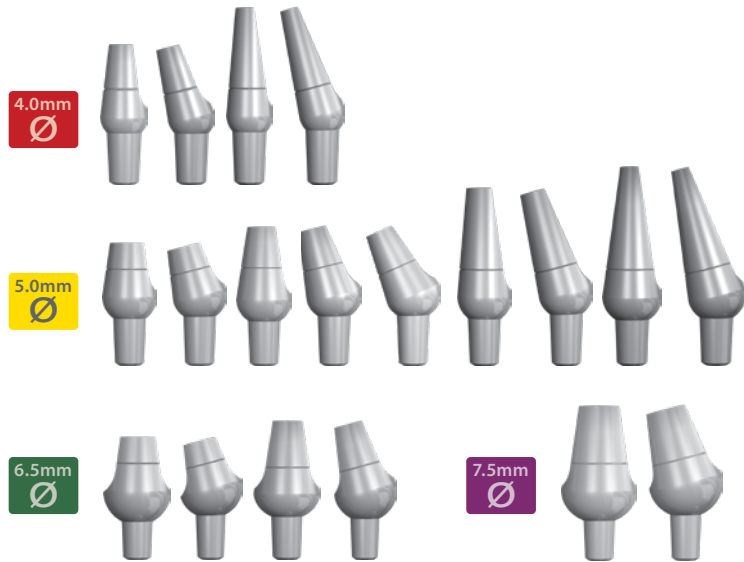

NON-SHOULDERED ABUTMENT PROSTHETIC COMPONENTS

Restorative and Laboratory Kits*

PART NO.	DIAMETER	LENGTH
140-465	4.0mm	6.5mm
140-410	4.0mm	10.0mm
150-450	5.0mm	5.0mm
150-465	5.0mm	6.5mm
150-410	5.0mm	10.0mm
150-412	5.0mm	12.0mm

PART NO.	DIAMETER	LENGTH
165-450	6.5mm	5.0mm
165-465	6.5mm	6.5mm
175-480	7.5mm	8.0mm

*Each kit contains (1) transfer die, (1) impression/waxing sleeve, and (1) temporization sleeve.

Temporization Sleeves (2)

PART NO.	DIAMETER
140-165	4.0mm
150-165	5.0mm
165-165	6.5mm
175-165	7.5mm

EMERGENCY CUFFS (4)

PART NO.	DIAMETER
140-010	4.0mm
150-010	5.0mm
165-065	6.5mm

STEALTH ABUTMENTS

2.0mm Post

PART NO.	DIAMETER	HEIGHT	ANGLE
200-150	3.5mm	1.5mm	0°
200-153	3.5mm	3.0mm	0°
200-200	4.0mm	1.5mm	0°
200-400	4.0mm	3.5mm	0°
200-201	5.0mm	2.0mm	0°
200-202	5.0mm	2.0mm	10°
200-221	5.0mm	4.0mm	0°
200-222	5.0mm	4.0mm	10°

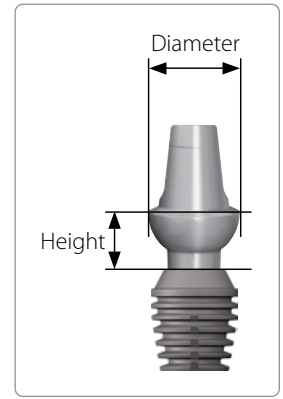
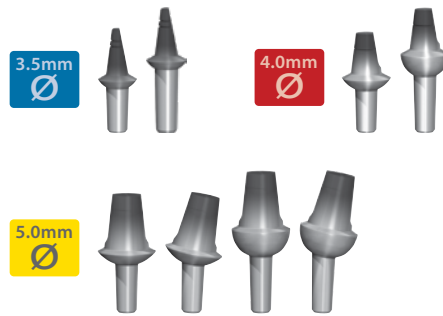

2.5mm Post

250-300	4.0mm	1.5mm	0°
250-400	4.0mm	3.5mm	0°
250-301	5.0mm	2.0mm	0°
250-302	5.0mm	2.0mm	10°
250-311	5.0mm	3.0mm	0°
250-312	5.0mm	3.0mm	10°
250-321	5.0mm	4.0mm	0°
250-322	5.0mm	4.0mm	10°
250-341	5.0mm	6.0mm	0°
250-342	5.0mm	6.0mm	10°

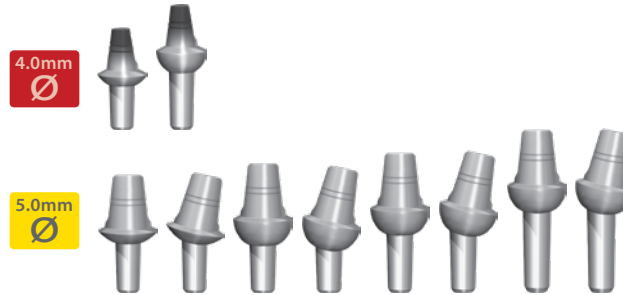

3.0mm Post

300-300	4.0mm	1.5mm	0°
300-400	4.0mm	3.5mm	0°
300-301	5.0mm	2.0mm	0°
300-302	5.0mm	2.0mm	10°
300-311	5.0mm	3.0mm	0°
300-312	5.0mm	3.0mm	10°
300-321	5.0mm	4.0mm	0°
300-322	5.0mm	4.0mm	10°
300-341	5.0mm	6.0mm	0°
300-342	5.0mm	6.0mm	10°
300-601	6.5mm	2.0mm	0°
300-602	6.5mm	2.0mm	10°
300-621	6.5mm	4.0mm	0°
300-622	6.5mm	4.0mm	10°

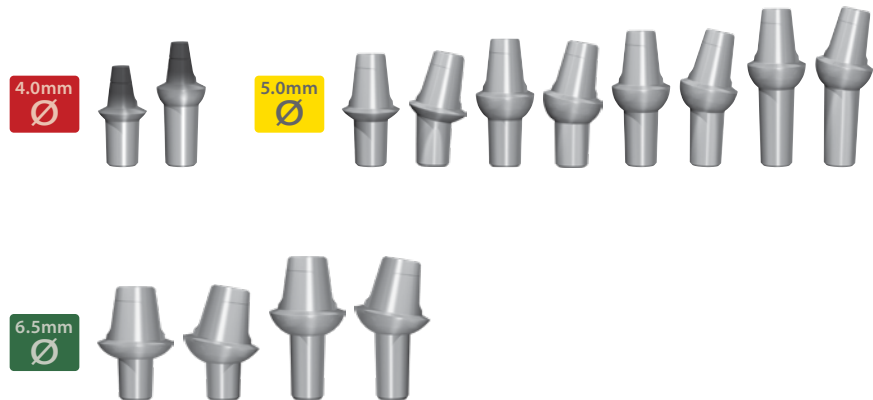

STEALTH ABUTMENT PROSTHETIC COMPONENTS

Sleeves* (4)



PART NO.	DESCRIPTION	HEIGHT
250-103	3.5mm Tall	10.0mm
250-104	4.0mm Tall	10.0mm
<i>Contains (4) beige sleeves.</i>		
250-105	5.0mm Tall	10.0mm
250-106	6.5mm Tall	10.0mm
<i>Contains (2) colored sleeves and (2) beige sleeves.</i>		

*The sleeves may be used for impression making, temporization, or as waxing sleeves.

Transfer Dies (2)

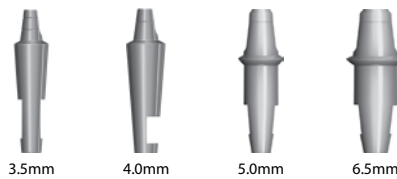

PART NO.	DESCRIPTION
250-183	3.5mm
250-184	4.0mm
<i>Contains (2) transfer dies and (2) beige sleeves.</i>	
250-185	5.0mm
250-186	6.5mm

Contains (2) transfer dies, (1) colored sleeve, and (1) beige sleeve.

BREVIS™ ABUTMENTS*

2.0mm Post

PART NO.	HEIGHT	ANGLE
100-404	2.0mm	0°
100-405	2.0mm	15°
100-406	4.0mm	0°
100-407	4.0mm	15°
100-408	6.0mm	0°
100-409	6.0mm	15°

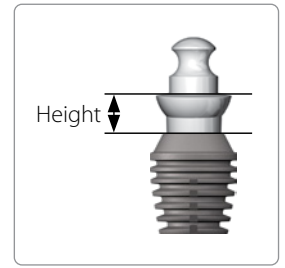

2.5mm Post

250-424	2.0mm	0°
250-425	2.0mm	15°
250-426	4.0mm	0°
250-427	4.0mm	15°
250-428	6.0mm	0°
250-429	6.0mm	15°

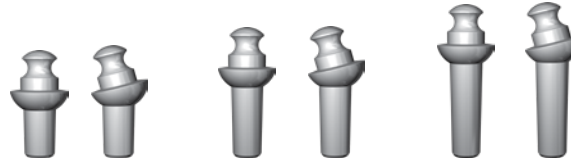

3.0mm Post

300-434	2.0mm	0°
300-435	2.0mm	15°
300-436	4.0mm	0°
300-437	4.0mm	15°
300-438	6.0mm	0°
300-439	6.0mm	15°



* Each abutment is packaged with one titanium Brevis housing with o-ring.

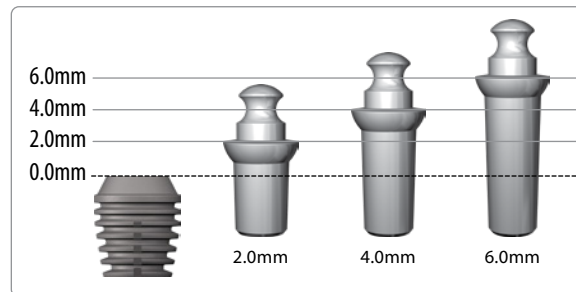

BREVIS™ ABUTMENT COMPONENTS



Rubber O-Rings
Enhanced Retention



Rubber O-Rings
Light Retention

PART NO.	DESCRIPTION
100-013	O-Rings - Enhanced (10)
100-014	O-Rings - Light (10)



Rubber
O-Ring



Brevis
Housing



Impression
Cap



Aluminum
Transfer Die

100-212	Brevis Housing
100-217	Impression Kit with Housing
100-218	Impression Kit without Housing

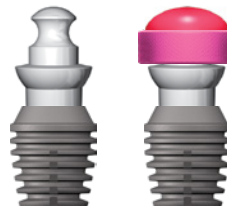

Brevis™ Abutment
with Housing

OVERDENTURE ABUTMENTS*

2.0mm Post

PART NO.	DIAMETER	HEIGHT
200-501	4.0mm	1.0mm
200-502	4.0mm	2.0mm
200-503	4.0mm	3.0mm
200-504	4.0mm	4.0mm
200-505	4.0mm	5.0mm

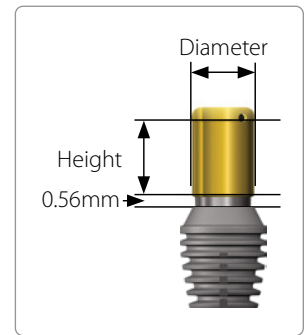
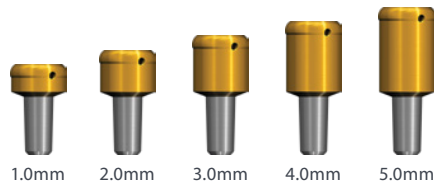

2.5mm Post

PART NO.	DIAMETER	HEIGHT
250-501	4.0mm	1.0mm
250-502	4.0mm	2.0mm
250-503	4.0mm	3.0mm
250-504	4.0mm	4.0mm
250-505	4.0mm	5.0mm

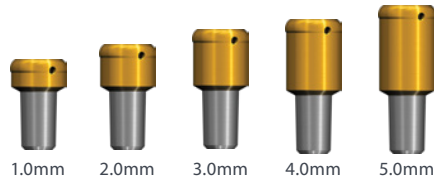

3.0mm Post

PART NO.	DIAMETER	HEIGHT
300-501	4.0mm	1.0mm
300-502	4.0mm	2.0mm
300-503	4.0mm	3.0mm
300-504	4.0mm	4.0mm
300-505	4.0mm	5.0mm

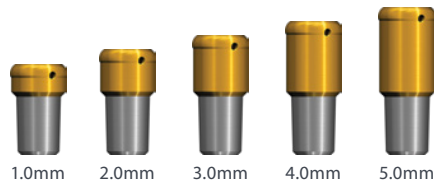

*Each Overdenture Abutment is packaged with a male processing kit. See Part Number 100-519 below.

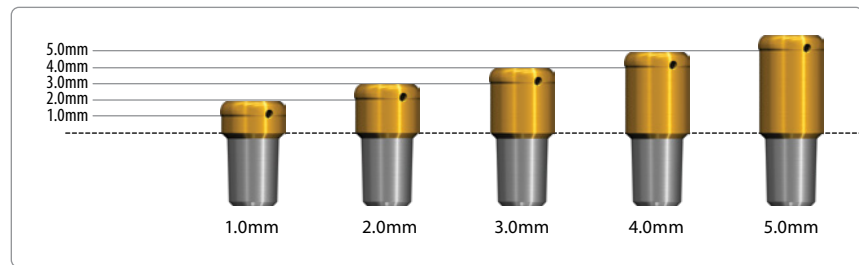

LOCATOR® OVERDENTURE ABUTMENT COMPONENTS

2.3 kg (5.0 lb.) Retention Male
1.4 kg (3.0 lb.) Retention Male
0.7 kg (1.5 lb.) Retention Male

Processing Male
Metal Housing Cap
Blockout Spacer

PART NO. DESCRIPTION
100-519 Male Processing Kit (2)

1.4 kg (3.0 lb.) Retention Cap
0.9 kg (2.0 lb.) Retention Cap
0.5 kg (1.0 lb.) Retention Cap

100-521 Extended Range Green Cap (4)
100-525 Extended Range Orange Cap (4)
100-526 Extended Range Red Cap (4)

Impression Cap
Impression Analog

PART NO. DESCRIPTION
100-524 Impression Kit

101-839 Core Tool

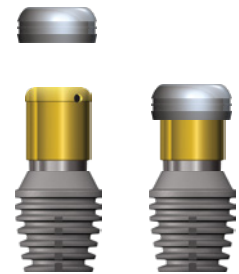

Overdenture Abutment with Housing

LOCATOR® is a registered trademark of Zest IP Holdings, LLC, and the LOCATOR® implant attachment system is manufactured by Zest Dental Solutions.

FIXED-DETACHABLE UNIVERSAL ABUTMENTS*

2.0mm Post

PART NO.	PROFILE	SHAFT	ANGLE
202-310	SP	Standard	0°
202-315	SP	Standard	15°
202-510	TP	Standard	0°
202-515	TP	Standard	15°
202-520	SP	Tall	0°
202-525	SP	Tall	15°
202-720	TP	Tall	0°
202-725	TP	Tall	15°

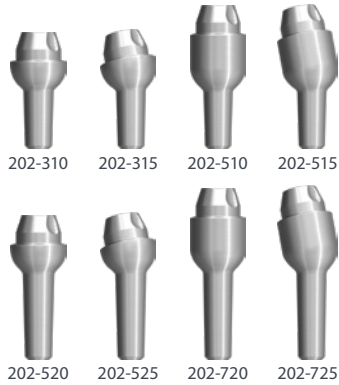

2.5mm Post

PART NO.	PROFILE	SHAFT	ANGLE
252-310	SP	Standard	0°
252-315	SP	Standard	15°
252-510	TP	Standard	0°
252-515	TP	Standard	15°
252-520	SP	Tall	0°
252-525	SP	Tall	15°
252-720	TP	Tall	0°
252-725	TP	Tall	15°

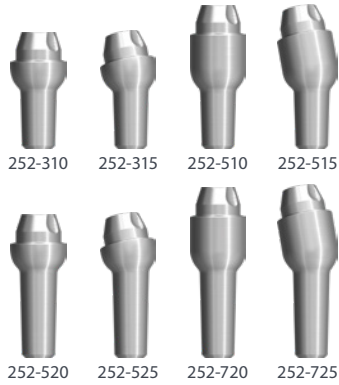

3.0mm Post

PART NO.	PROFILE	SHAFT	ANGLE
302-310	SP	Standard	0°
302-315	SP	Standard	15°
302-510	TP	Standard	0°
302-515	TP	Standard	15°
302-520	SP	Tall	0°
302-525	SP	Tall	15°
302-720	TP	Tall	0°
302-725	TP	Tall	15°

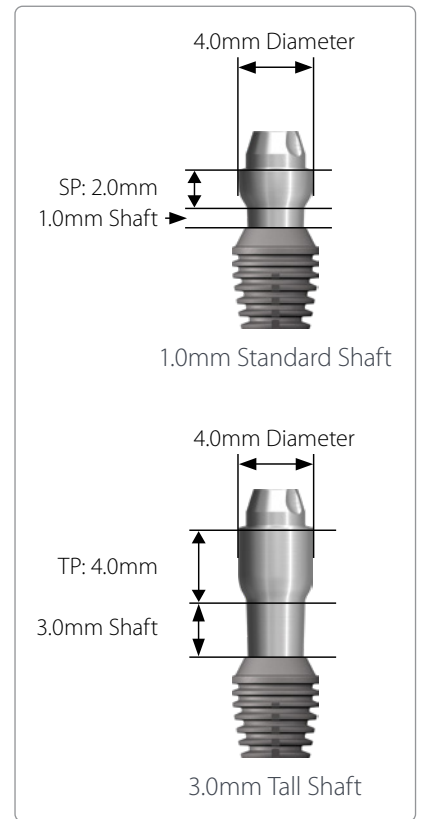
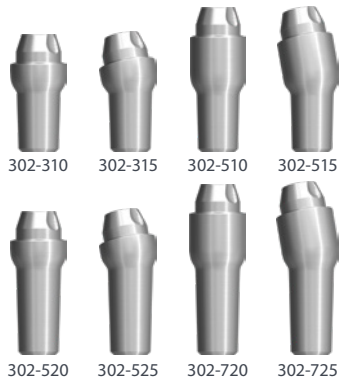

*PROFILE LEGEND

SP: Standard Profile = 2.0mm
TP: Tall Profile = 4.0mm

FIXED-DETACHABLE UNIVERSAL ABUTMENT COMPONENTS

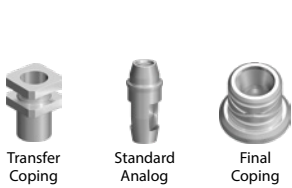

PART NO.	DESCRIPTION
100-135	Titanium Transfer Coping (2)
100-130	Titanium Standard Abutment Analog (2)
100-140	Titanium Final Coping (2)

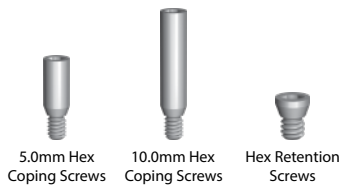

PART NO.	DESCRIPTION
100-016	5.0mm Hex Coping Screws (4)
100-017	10.0mm Hex Coping Screws (4)
100-020	Hex Retention Screws (4)



PART NO.	DESCRIPTION
101-024	10mm Hex Screwdriver
101-026	20mm Hex Screwdriver

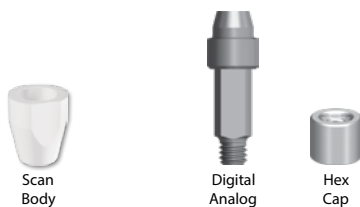

100-640	Scan Body (2)
100-049	Digital Abutment Analog and Cap



FIXED-DETACHABLE ABUTMENTS*

2.0mm Post

PART NO.	DIAMETER	HEIGHT	ANGLE
100-003	4.0mm	3.0mm	0°
100-015	4.0mm	3.0mm	15°
100-004	4.0mm	5.0mm	0°
100-115	4.0mm	5.0mm	15°

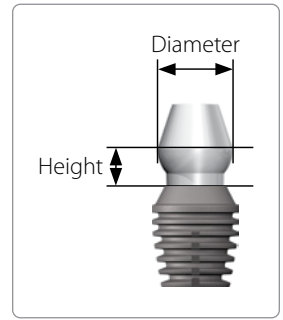

2.5mm Post

250-213	4.0mm	3.0mm	0°
250-215	4.0mm	3.0mm	15°
250-214	4.0mm	5.0mm	0°
250-255	4.0mm	5.0mm	15°



3.0mm Post

300-003	4.0mm	3.0mm	0°
300-015	4.0mm	3.0mm	15°
300-004	4.0mm	5.0mm	0°
300-115	4.0mm	5.0mm	15°



*For screw-retained TRINIA® and cast bar restorations.

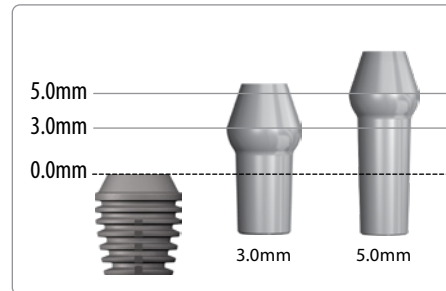

FIXED-DETACHABLE COMPONENTS*



PART NO.	DESCRIPTION
100-005	Plastic Transfer and Castable Coping (4)
100-019	Titanium Transfer Coping (4)
100-006	Titanium Standard Analog (4)
100-022	Titanium Final Coping (2)



PART NO.	DESCRIPTION
100-016	5.0mm Hex Coping Screws (4)
100-017	10.0mm Hex Coping Screws (4)
100-020	Hex Retention Screws (4)
100-021	Hex Cover Screws (4)



PART NO.	DESCRIPTION
101-024	10mm Hex Screwdriver
101-026	20mm Hex Screwdriver

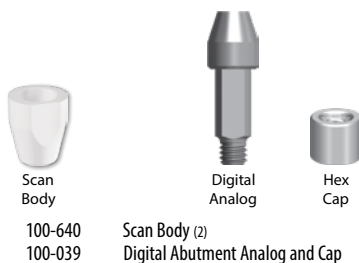

100-640	Scan Body (2)
100-039	Digital Abutment Analog and Cap





The **REVOLUTIONARY** Metal-Free CAD/CAM Material

WHY TRINIA®?

Dentists and technicians are seeking alternatives to metal substructures with improved clinical capabilities. TRINIA® is today's CAD/CAM solution for metal-free restorations.



ONLY TRINIA®

- Biocompatible and metal-free
- Modifiable and repairable
- Lightweight and flexible
- No firing required
- Provides for longer distal extensions

TRINIA®

PART NO.	DESCRIPTION	SIZE	COLOR
612-115	TRINIA® Disc	98mm x 15mm	Ivory
612-125	TRINIA® Disc	98mm x 25mm	Ivory
612-215	TRINIA® Disc	98mm x 15mm	Pink
612-225	TRINIA® Disc	98mm x 25mm	Pink
613-115	TRINIA® Block (2)	55 x 19 x 15mm	Ivory
614-115	TRINIA® Block (2)	40 x 19 x 15mm	Ivory



Fixed Prostheses



Prosthetic Frameworks



Removable Prosthetics

TRINIA® EPC*

PART NO.	DESCRIPTION	SIZE	COLOR
616-115	TRINIA® EPC Block (2)	40 x 19 x 15mm	Ivory



Ivory TRINIA® EPC Block

*Designed for the digital fabrication of endodontic post and core restorations.

DRILL UNIT AND HANDPIECES



PART NO.	DESCRIPTION
028-150	Electric Drill System
028-425	Motor for Drill Unit



028-201	20:1 High Torque Handpiece
---------	----------------------------

SURGICAL AND RESTORATIVE KITS

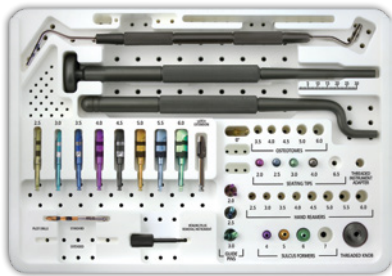

Introductory Surgical Kit



Comprehensive Surgical Kit



Advanced Surgical Kit



Restorative Kit

PART NO.	DESCRIPTION
101-057	Introductory
101-098	Comprehensive
101-095	Advanced
101-096	Restorative

INSTRUMENTATION TRAYS

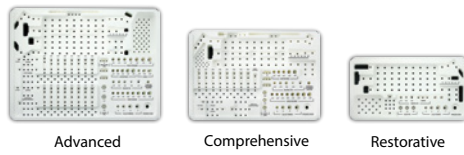

PART NO.	DESCRIPTION
104-993	Advanced
104-994	Comprehensive
104-996	Restorative

PILOT DRILLS (Stainless Steel)



2.0mm Standard Pilot Drill 2.0mm Extended Pilot Drill

PART NO.	DESCRIPTION
101-001	2.0mm Standard
101-002	2.0mm Extended

DRILL STOP PILOT DRILLS (Stainless Steel)

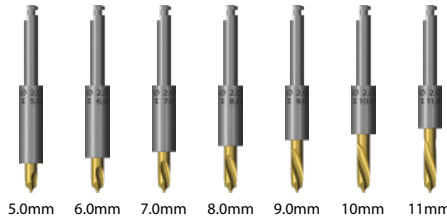

PART NO.	DESCRIPTION
101-105	2.0mm Pilot Drill - 5.0mm Stop
101-106	2.0mm Pilot Drill - 6.0mm Stop
101-107	2.0mm Pilot Drill - 7.0mm Stop
101-108	2.0mm Pilot Drill - 8.0mm Stop
101-109	2.0mm Pilot Drill - 9.0mm Stop
101-110	2.0mm Pilot Drill - 10mm Stop
101-111	2.0mm Pilot Drill - 11mm Stop



2.0mm Pilot Drill Stop Kit

PART NO.	DESCRIPTION
101-099	2.0mm Pilot Drill Stop Kit
104-999	2.0mm Pilot Drill Stop Tray

STANDARD LATCH REAMERS (Ti6Al4V)



PART NO.	DESCRIPTION
101-125	2.5mm
101-130	3.0mm
101-135	3.5mm
101-140	4.0mm
101-645	4.5mm
101-650	5.0mm
101-655	5.5mm
101-660	6.0mm
101-120	Standard Latch Reamer Set

EXTENDED LATCH REAMERS (Ti6Al4V)



101-325	2.5mm
101-330	3.0mm
101-335	3.5mm
101-340	4.0mm
101-345	4.5mm
101-350	5.0mm
101-355	5.5mm
101-360	6.0mm
101-121	Extended Latch Reamer Set

HAND REAMERS (Ti6Al4V)



101-025	2.5mm
101-030	3.0mm
101-035	3.5mm
101-040	4.0mm
101-045	4.5mm
101-050	5.0mm
101-055	5.5mm
101-060	6.0mm
101-122	Hand Reamer Set*

*Includes straight handle, threaded instrument adapter, and reamer removal wrench

REAMER REMOVAL WRENCH



101-017	Removal Wrench
---------	----------------

LATCH REAMER EXTENDER



PART NO.	DESCRIPTION
101-022	Latch Reamer Extender

PARALLELING PIN



701-001	Paralleling Pin
---------	-----------------

GAUGES



Double Ended Osteotomy Depth Gauge



Abutment Shoulder Depth Gauge

101-370	Double Ended Osteotomy Depth Gauge
101-380	Abutment Shoulder Depth Gauge

THREADED COMPONENTS

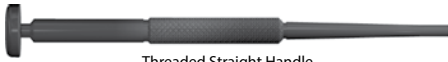

Threaded Straight Handle



Threaded Offset Handle



Threaded Knob



Threaded Instrument Adapter

101-016	Threaded Straight Handle
101-009	Threaded Offset Handle
101-014	Threaded Knob
101-020	Threaded Instrument Adapter*

*For use with Sulcus Formers, Hand Reamers and Tissue Punches

HEALING PLUG INSTRUMENTS



Healing Plug Cutter



Healing Plug Removal Instrument (Manual)

801-001	Healing Plug Cutter
101-114	Removal Instrument (Manual)

SEATING TIPS



PART NO.	DESCRIPTION
101-010	2.0mm
101-258	2.5mm
101-018	3.0mm
101-012	Standard
101-019	Large

INSERTER AND RETRIEVER

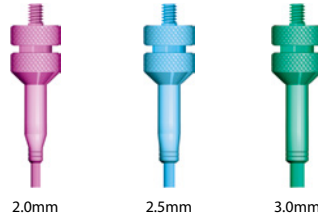

101-005	2.0mm
101-007	2.5mm
101-006	3.0mm

SULCUS FORMERS*



101-440	4 Series
101-450	5 Series
101-465	6 Series
101-475	7 Series

*Packaged with one each of 2.0mm, 2.5mm, and 3.0mm Standard Guide Pins.

GUIDE PINS (4)

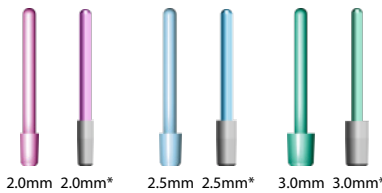

101-180	2.0mm Standard
101-280	2.0mm Tall*
101-186	2.5mm Standard
101-286	2.5mm Tall*
101-183	3.0mm Standard
101-283	3.0mm Tall*

*Tall shafts are 2.0mm taller than standard shafts and are helpful for deeply-positioned implants often avoiding the need for removing bone over the implant with sulcus formers.

BONE EXPANDERS



PART NO.	DESCRIPTION
901-430	3.0mm
901-435	3.5mm
901-440	4.0mm
901-445	4.5mm
901-450	5.0mm
901-455	5.5mm
901-460	6.0mm
101-123	Bone Expander Set

OSTEOTOMES



901-535	3.5mm
901-540	4.0mm
901-545	4.5mm
901-550	5.0mm
901-560	6.0mm
101-124	Osteotome Set

CURVED CHISELS



901-645	4.5mm
901-650	5.0mm
901-660	6.0mm
101-126	Curved Chisel Set

EXPANDING CHISELS



901-613	3.0mm
901-615	5.0mm
901-616	6.0mm

TISSUE PUNCHES



101-540	4.0mm
101-550	5.0mm
101-565	6.5mm

PERIOTOMES

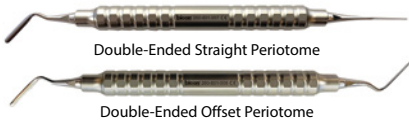

PART NO.	DESCRIPTION
801-007	Double-Ended Straight Periostome
801-008	Double-Ended Offset Periostome

SINUS CURETTES AND BUR

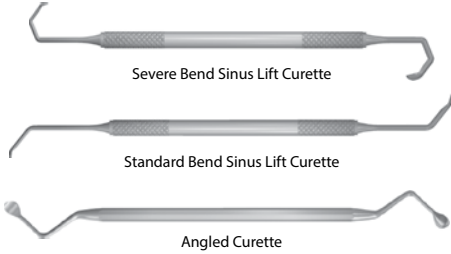

801-515	Severe Bend Sinus Lift Curette
801-517	Standard Bend Sinus Lift Curette
801-522	Angled Curette

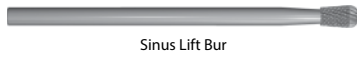

201-029	Sinus Lift Bur
---------	----------------

TREPHINES

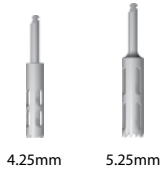

801-840	4.25mm (5.2mm OD)
801-850	5.25mm (6.2mm OD)

IMPLANT SPACING TEMPLATE



101-305	Implant Spacing Template
---------	--------------------------

ABUTMENT FORCEPS



PART NO.	DESCRIPTION
801-002	Carrying Forceps
801-055	Removal Forceps (Upper)
801-056	Removal Forceps (Lower)

MALLET



801-165	Mallet
---------	--------

SILICONE DAPPEN DISH



103-030	Silicone Dappen Dish
---------	----------------------

COTTON TIP APPLICATORS

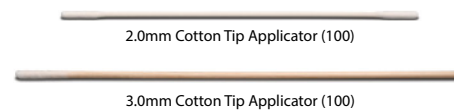

103-027	2.0mm (100)
103-028	3.0mm (100)

SHADE ENHANCER



103-006	Bicon Shade Enhancer
---------	----------------------

ABUTMENT PREPARATION

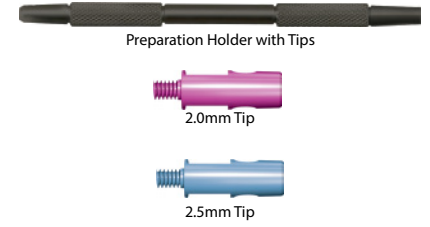

PART NO.	DESCRIPTION
101-395	Preparation Holder with tips
701-382	2.0mm Tip
701-385	2.5mm Tip



155-701	#1557 Regular Length Bur (5)
201-011	11.0mm Abutment Cutting Bur
155-704	#4 Round Bur Regular Length (5)

IAC® POLISHING KIT



103-033	IAC® Polishing Kit
---------	--------------------

CROWN ALIGNMENT DEVICE

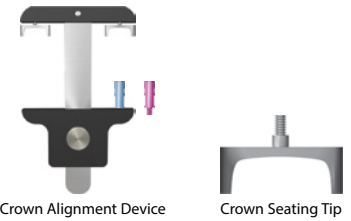

101-315	Crown Alignment Device
101-015	Crown Seating Tip

HYDROPLASTIC RESIN



103-031	Hydroplastic Resin (20g)
---------	--------------------------

GUIDED SURGERY KITS

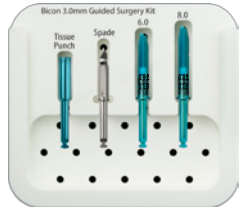

3.0mm

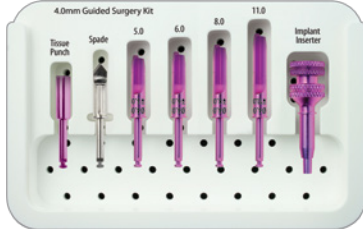

4.0mm

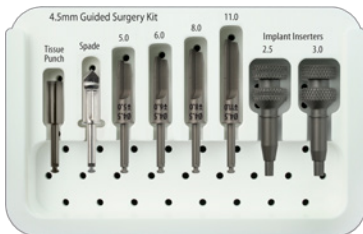

4.5mm

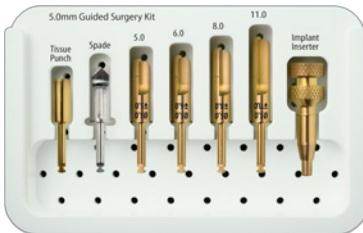

5.0mm

PART NO.	DESCRIPTION
101-830	3.0mm
101-840	4.0mm
101-845	4.5mm
101-850	5.0mm

GUIDED PILOT DRILLS (2.0mm)



2.0 x 5.0mm 2.0 x 6.0mm 2.0 x 8.0mm 2.0 x 11.0mm

PART NO.	DESCRIPTION
920-350	2.0 x 5.0mm
920-360	2.0 x 6.0mm
920-380	2.0 x 8.0mm
920-311	2.0 x 11.0mm
101-820	2.0mm Guided Pilot Drill Kit

GUIDED SURGERY REAMERS



3.0 x 6.0mm 3.0 x 8.0mm



4.0 x 5.0mm 4.0 x 6.0mm 4.0 x 8.0mm 4.0 x 11.0mm



4.5 x 5.0mm 4.5 x 6.0mm 4.5 x 8.0mm 4.5 x 11.0mm



5.0 x 5.0mm 5.0 x 6.0mm 5.0 x 8.0mm 5.0 x 11.0mm

PART NO.	DIAMETER	LENGTH
930-360	3.0mm	6.0mm
930-380	3.0mm	8.0mm
940-350	4.0mm	5.0mm
940-360	4.0mm	6.0mm
940-380	4.0mm	8.0mm
940-311	4.0mm	11.0mm
945-350	4.5mm	5.0mm
945-360	4.5mm	6.0mm
945-380	4.5mm	8.0mm
945-311	4.5mm	11.0mm
950-350	5.0mm	5.0mm
950-360	5.0mm	6.0mm
950-380	5.0mm	8.0mm
950-311	5.0mm	11.0mm

GUIDED INSERTERS



4.0 x 2.5mm 4.5 x 2.5mm 4.5 x 3.0mm 5.0 x 3.0mm

PART NO.	DIAMETER	POST
940-425	4.0mm	2.5mm
945-425	4.5mm	2.5mm
945-430	4.5mm	3.0mm
950-430	5.0mm	3.0mm

GUIDE RINGS (5)



PART NO.	DIAMETER
920-005	2.0mm
930-005	3.0mm
940-005	4.0mm
945-005	4.5mm
950-005	5.0mm

GUIDED SPADE DRILLS



3.0mm 4.0mm 4.5mm 5.0mm

930-201	3.0mm
940-201	4.0mm
945-201	4.5mm
950-201	5.0mm

GUIDED TISSUE PUNCHES



3.0mm 4.0mm 4.5mm 5.0mm

930-101	3.0mm
940-101	4.0mm
945-101	4.5mm
950-101	5.0mm

DEMONSTRATION MODELS

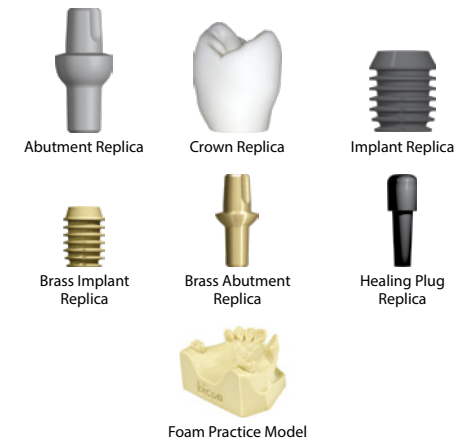

102-501	Abutment Replica UAS (10x)
102-510	Crown Replica (10x)
102-508	Implant Replica 5.0 x 6.0mm (10x)
545-306	Brass 4.5 x 6.0mm Implant 3.0mm Well
850-700	Brass Universal Abutment UAS LP 0° 3.0mm Post
700-001	3.0mm Healing Plug Inserter Replica
102-104	Foam Practice Model